

MOTOROLA
Semiconductors

3501 ED BLUESTEIN BLVD., AUSTIN, TEXAS 78721

Advance Information

1.5 AND 2.0 MHz COMPONENTS FOR THE M6800 MICROCOMPUTER SYSTEM

The eight devices described in this data sheet extend the operating frequency of the M6800 Microcomputer Family. The block diagrams and device operation are the same as for the basic M6800-series components.

- Fully Hardware and Software Compatible with the M6800 Family
- Power Dissipation Approximately 20% Lower Than on Standard MC6800 Series
- Clock Specification Improved for Reduced Complexity of Clock Generator/Driver Circuitry
- The MC6821 and its higher-frequency versions provide drive capability of two TTL loads on all A- and B-side buffers, improving the drive capability of the MC6820.

**M6800 MICROCOMPUTER FAMILY
BLOCK DIAGRAM**

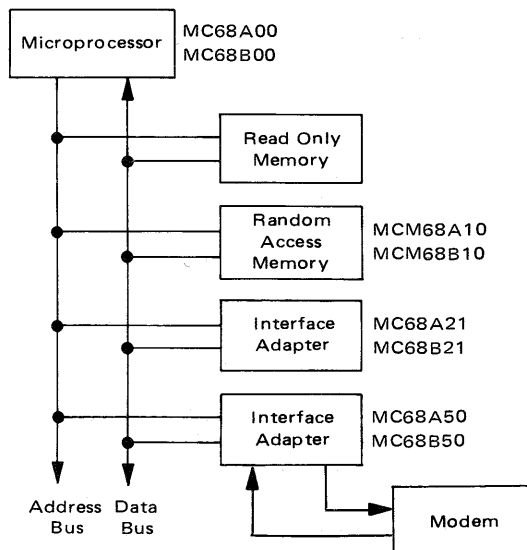

1.5 MHz

2.0 MHz

MC68A00•MC68B00

MPU

MC68A21•MC68B21

PIA

MC68A50•MC68B50

ACIA

MCM68A10•MCM68B10

RAM

MOS

(N-CHANNEL, SILICON-GATE)

**MICROPROCESSOR SYSTEM
COMPONENTS**

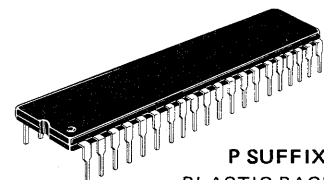

P SUFFIX
PLASTIC PACKAGE
CASE 711

NOT SHOWN: **L SUFFIX**
CERAMIC PACKAGE
CASE 715

For additional information on these devices—including block diagrams, signal descriptions, device operation and pin assignments—refer to the *M6800 Microcomputer System Design Data* brochure.

MICROPROCESSING UNIT (MPU)
MC68A00 • MC68B00

ELECTRICAL CHARACTERISTICS ($V_{CC} = 5.0\text{ V}$, $\pm 5\%$, $V_{SS} = 0$, $T_A = 0$ to 70°C unless otherwise noted.)

Characteristic	Symbol	Min	Typ	Max	Unit	
Input High Voltage Logic $\phi 1, \phi 2$	V_{IH}	$V_{SS} + 2.0$	—	V_{CC}	Vdc	
	V_{IHC}	$V_{CC} - 0.6$	—	$V_{CC} + 0.3$		
Input Low Voltage Logic $\phi 1, \phi 2$	V_{IL}	$V_{SS} - 0.3$	—	$V_{SS} + 0.8$	Vdc	
	V_{ILC}	$V_{SS} - 0.3$	—	$V_{SS} + 0.4$		
Input Leakage Current ($V_{in} = 0$ to 5.25 V , $V_{CC} = \text{max}$) ($V_{in} = 0$ to 5.25 V , $V_{CC} = 0.0\text{ V}$)	Logic* $\phi 1, \phi 2$	—	1.0	2.5	μAdc	
		—	—	100		
Three-State (Off State) Input Current ($V_{in} = 0.4$ to 2.4 V , $V_{CC} = \text{max}$)	D0–D7	—	2.0	10	μAdc	
	A0–A15, R/W	—	—	100		
Output High Voltage ($I_{Load} = -205\ \mu\text{Adc}$, $V_{CC} = \text{min}$) ($I_{Load} = -145\ \mu\text{Adc}$, $V_{CC} = \text{min}$) ($I_{Load} = -100\ \mu\text{Adc}$, $V_{CC} = \text{min}$)	D0–D7	$V_{SS} + 2.4$	—	—	Vdc	
	A0–A15, R/W, VMA	$V_{SS} + 2.4$	—	—		
	BA	$V_{SS} + 2.4$	—	—		
		$V_{SS} + 2.4$	—	—		
Output Low Voltage ($I_{Load} = 1.6\ \text{mA}$, $V_{CC} = \text{min}$)	V_{OL}	—	—	$V_{SS} + 0.4$	Vdc	
Power Dissipation	P_D	—	0.5	1.0	W	
Capacitance # ($V_{in} = 0$, $T_A = 25^\circ\text{C}$, $f = 1.0\ \text{MHz}$)	C_{in}	$\phi 1$	—	—	35	pF
		$\phi 2$	—	—	70	
		D0–D7	—	10	12.5	
	Logic Inputs A0–A15, R/W, VMA	C_{out}	—	—	12	pF
Frequency of Operation	MC68A00	0.1	—	1.5	MHz	
	MC68B00	0.1	—	2.0		
Clock Timing (Figure 1) Cycle Time	MC68A00	0.666	—	10	μs	
	MC68B00	0.50	—	10		
Clock Pulse Width (Measured at $V_{CC} - 0.6\text{ V}$)	$\phi 1, \phi 2$ – MC68A00	230	—	9500	ns	
	$\phi 1, \phi 2$ – MC68B00	180	—	9500		
Total $\phi 1$ and $\phi 2$ Up Time	MC68A00	600	—	—	ns	
	MC68B00	440	—	—		
Rise and Fall Times (Measured between $V_{SS} + 0.4$ and $V_{CC} - 0.6$)	$t_{\phi r}, t_{\phi f}$	5.0	—	100	ns	
Delay Time or Clock Separation (Measured at $V_{OV} = V_{SS} + 0.6\text{ V}$)	t_d	0	—	9100	ns	

*Except IRQ and NMI, which require a $3.0\ \text{k}\Omega$ pullup load resistor for wire-OR capability at optimum operation.

#Capacitances are periodically sampled rather than 100% tested.



READ/WRITE TIMING

Characteristic	Symbol	MC68A00			MC68B00			Unit
		Min	Typ	Max	Min	Typ	Max	
Address Delay C = 90 pF C = 30 pF	t _{AD}	—	—	180	—	—	150	ns
		—	—	165	—	—	135	
Peripheral Read Access Time t _{ac} = t _{ut} - (t _{AD} + t _{DSR})	t _{acc}	—	—	360	—	—	250	ns
Data Setup Time (Read)	t _{DSR}	60	—	—	40	—	—	ns
Input Data Hold Time	t _H	10	—	—	10	—	—	ns
Output Data Hold Time	t _H	10	25	—	10	25	—	ns
Address Hold Time (Address, R/W, VMA)	t _{AH}	10	75	—	10	75	—	ns
Enable High Time for DBE Input	t _{EH}	280	—	—	220	—	—	ns
Data Delay Time (Write)	t _{DDW}	—	165	200	—	—	160	ns
Processor Controls								
Processor Control Setup Time	t _{PCS}	200	—	—	200	—	—	ns
Processor Control Rise and Fall Time	t _{PCr} , t _{PCf}	—	—	100	—	—	100	ns
Bus Available Delay	t _{BA}	—	—	270	—	—	270	ns
Three-State Enable	t _{TSE}	—	—	40	—	—	40	ns
Three-State Delay	t _{TSD}	—	—	270	—	—	270	ns
Data Bus Enable Down Time During φ1 Up Time	t _{DBE}	150	—	—	70	—	—	ns
Data Bus Enable Rise and Fall Times	t _{DBEr} , t _{DBEf}	—	—	25	—	—	25	ns

FIGURE 1 – CLOCK TIMING WAVEFORM

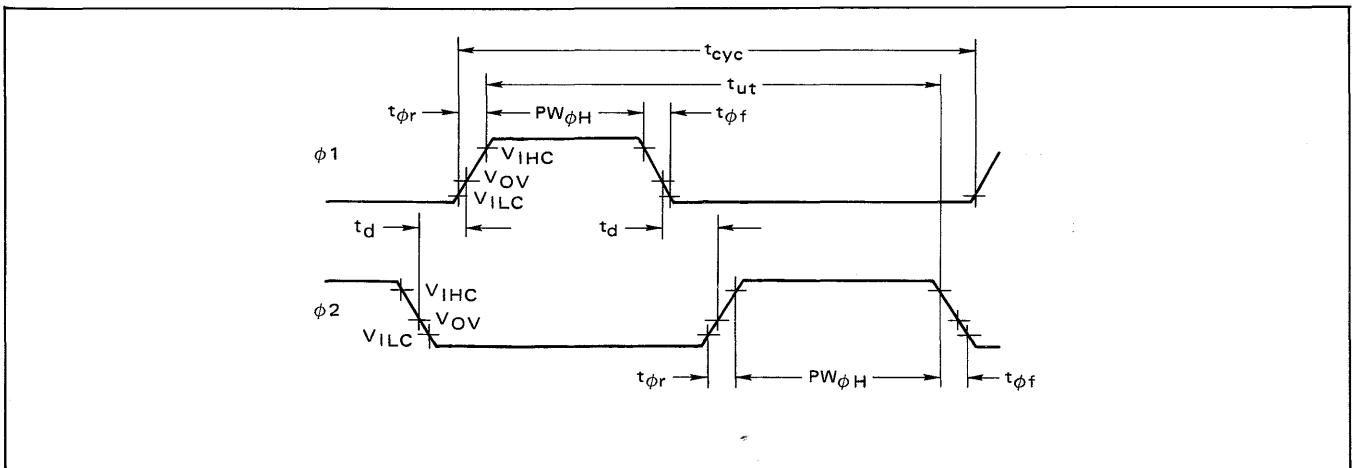
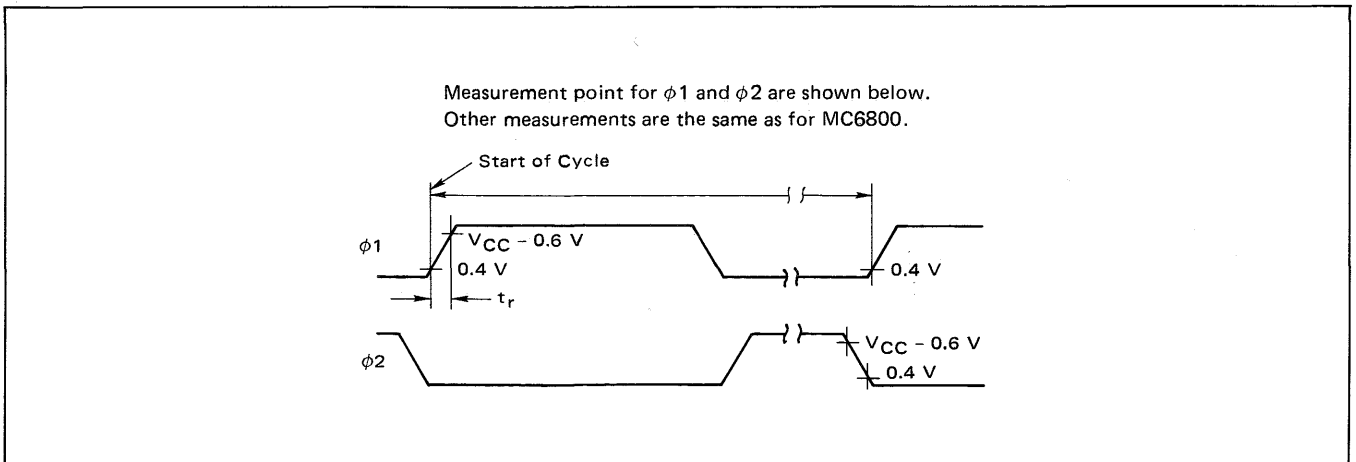

FIGURE 2 – READ/WRITE TIMING WAVEFORM



PERIPHERAL INTERFACE ADAPTER (PIA)
MC68A21 • MC68B21

ELECTRICAL CHARACTERISTICS ($V_{CC} = 5.0 \text{ V} \pm 5\%$, $V_{SS} = 0$, $T_A = 0$ to 70°C unless otherwise noted.)

Characteristic	Symbol	Min	Typ	Max	Unit	
Input High Voltage	V_{IH}	$V_{SS} + 2.0$	—	V_{CC}	Vdc	
Input Low Voltage	V_{IL}	$V_{SS} - 0.3$	—	$V_{SS} + 0.8$	Vdc	
Input Leakage Current ($V_{in} = 0$ to 5.25 Vdc)	R/W, $\overline{\text{Reset}}$, RS0, RS1, CS0, CS2, CS1, CA1, CB1, Enable	I_{in}	—	1.0	2.5	μA dc
Three-State (Off State) Input Current ($V_{in} = 0.4$ to 2.4 Vdc)	D0–D7, PB0–PB7, CB2	I_{TSI}	—	2.0	10	μA dc
Input High Current ($V_{IH} = 2.4 \text{ Vdc}$)	PA0–PA7, CA2	I_{IH}	–200	–400	—	μA dc
Input Low Current ($V_{IL} = 0.4 \text{ Vdc}$)	PA0–PA7, CA2	I_{IL}	—	–1.3	–2.4	mAdc
Output High Voltage ($I_{Load} = -205 \mu\text{A}$) ($I_{Load} = -200 \mu\text{A}$)	D0–D7 Other Outputs	V_{OH}	$V_{SS} + 2.4$ $V_{SS} + 2.4$	— —	— —	Vdc
Output Low Voltage ($I_{Load} = 1.6 \text{ mAdc}$) ($I_{Load} = 3.2 \text{ mAdc}$)	D0–D7 Other Outputs	V_{OL}	— —	— —	$V_{SS} + 0.4$ $V_{SS} + 0.4$	Vdc
Output High Current (Sourcing) ($V_{OH} = 2.4 \text{ Vdc}$) ($V_O = 1.5 \text{ Vdc}$, the current for driving other than TTL, e.g., Darlington Base)	D0–D7 Other Outputs PB0–PB7, CB2	I_{OH}	–205 –100 –1.0	— — –2.5	— — –10	μA dc μA dc mAdc
Output Leakage Current (Off State) ($V_{OH} = 2.4 \text{ Vdc}$)	$\overline{\text{IRQA}}$, $\overline{\text{IRQB}}$	I_{LOH}	—	1.0	10	μA dc
Power Dissipation	P_D	—	—	550	mW	
Capacitance ($V_{in} = 0$, $T_A = 25^\circ\text{C}$, $f = 1.0 \text{ MHz}$)	D0–D7 PA0–PA7, PB0–PB7, CA2, CB2 Enable, R/W, $\overline{\text{Reset}}$, RS0, RS1, CS0, CS1, CS2, CA1, CB1 $\overline{\text{IRQA}}$, $\overline{\text{IRQB}}$	C_{in}	— — —	— — —	12.5 10 7.5	pF
		C_{out}	—	—	5.0	pF

NOTE:

The PA0–PA7 Peripheral Data lines and the CA2 Peripheral Control line can drive two standard TTL loads. In the input mode, the internal pullup resistor on these lines represents a maximum of 1.5 standard TTL loads.



TIMING CHARACTERISTICS ($V_{CC} = 5.0\text{ V} \pm 5\%$, $V_{SS} = 0$, $T_A = 0$ to 70°C unless otherwise noted.)

Characteristic	Symbol	MC68A21		MC68B21		Unit
		Min	Max	Min	Max	
Peripheral Data Setup Time	t_{PDSU}	135	—	100	—	ns
Peripheral Data Hold Time	t_{PDH}	0	—	0	—	ns
Delay Time, Enable negative transition to CA2 negative transition	t_{CA2}	—	0.670	—	0.5	μs
Delay Time, Enable negative transition to CA2 positive transition	t_{RS1}	—	0.670	—	0.5	μs
Rise and Fall Times for CA1 and CA2 input signals	t_r, t_f	—	1.0	—	1.0	μs
Delay Time from CA1 active transition to CA2 positive transition	t_{RS2}	—	1.35	—	1.0	μs
Delay Time, Enable negative transition to Peripheral Data Valid	t_{PDW}	—	0.670	—	0.5	μs
Delay Time, Enable negative transition to Peripheral CMOS Data Valid ($V_{CC} - 30\%$, V_{CC} ; Figure 6, Load C) PA0–PA7, CA2	t_{CMOS}	—	1.35	—	1.0	μs
Delay Time, Enable positive transition to CB2 negative transition	t_{CB2}	—	0.670	—	0.5	μs
Delay Time, Peripheral Data Valid to CB2 negative transition	t_{DC}	20	—	20	—	ns
Delay Time, Enable positive transition to CB2 positive transition	t_{RS1}	—	0.670	—	0.5	μs
Peripheral Control Output Pulse Width, CA2/CB2	PW_{CT}	550	—	550	—	ns
Rise and Fall Time for CB1 and CB2 input signals	t_r, t_f	—	1.0	—	1.0	μs
Delay Time, CB1 active transition to CB2 positive transition	t_{RS2}	—	1.35	—	1.0	μs
Interrupt Release Time, IRQA and IRQB	t_{IR}	—	1.1	—	0.85	μs
Interrupt Response Time	t_{RS3}	—	1.0	—	1.0	μs
Interrupt Input Pulse Width	PW_I	500	—	500	—	ns
Reset Low Time*	t_{RL}	0.66	—	0.5	—	μs

*The Reset line must be high a minimum of $1.0\ \mu\text{s}$ before addressing the PIA.

BUS TIMING CHARACTERISTICS ($V_{CC} = 5.0\text{ V} \pm 5\%$, $V_{SS} = 0$, $T_A = 0$ to 70°C unless otherwise noted.)**READ**

Characteristic	Symbol	MC68A21		MC68B21		Unit
		Min	Max	Min	Max	
Enable Cycle Time	t_{cycE}	0.666	—	0.50	—	μs
Enable Pulse Width, High	PW_{EH}	0.280	—	0.22	—	μs
Enable Pulse Width, Low	PW_{EL}	0.280	—	0.21	—	μs
Setup Time, Address and R/W Valid to Enable positive transition	t_{AS}	140	—	70	—	ns
Data Delay Time	t_{DDR}	—	220	—	180	ns
Data Hold Time	t_H	10	—	10	—	ns
Address Hold Time	t_{AH}	10	—	10	—	ns
Rise and Fall Time for Enable input	t_{Er}, t_{Ef}	—	25	—	25	ns

WRITE

Enable Cycle Time	t_{cycE}	0.666	—	0.50	—	μs
Enable Pulse Width, High	PW_{EH}	0.280	—	0.22	—	μs
Enable Pulse Width, Low	PW_{EL}	0.280	—	0.21	—	μs
Setup Time, Address and R/W Valid to Enable positive transition	t_{AS}	140	—	70	—	ns
Data Setup Time	t_{DSW}	80	—	60	—	ns
Data Hold Time	t_H	10	—	10	—	ns
Address Hold Time	t_{AH}	10	—	10	—	ns
Rise and Fall Time for Enable input	t_{Er}, t_{Ef}	—	25	—	25	ns



NOTES:

1. Figures shown are only those needed to define new measurements *not* specified on the MC6820 data sheet (page 39 of M6800 Microcomputer System Design Data). Refer to that data sheet, or to the new MC6821 data sheet, for further information.

2. On all tests, measurements on the Enable pulse are at 0.8 V and 2.0 V.

FIGURE 3 – PERIPHERAL DATA HOLD TIME (Read Mode)

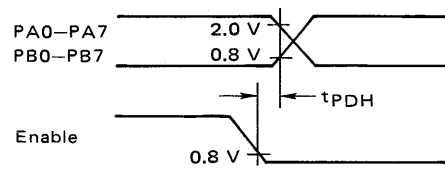

FIGURE 4 – PERIPHERAL CONTROL OUTPUT PULSE WIDTH

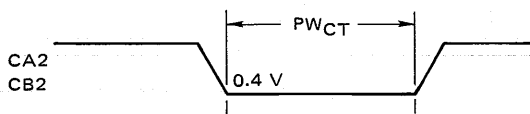
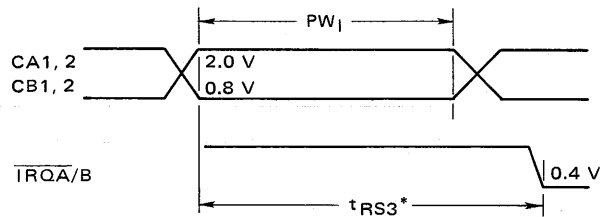
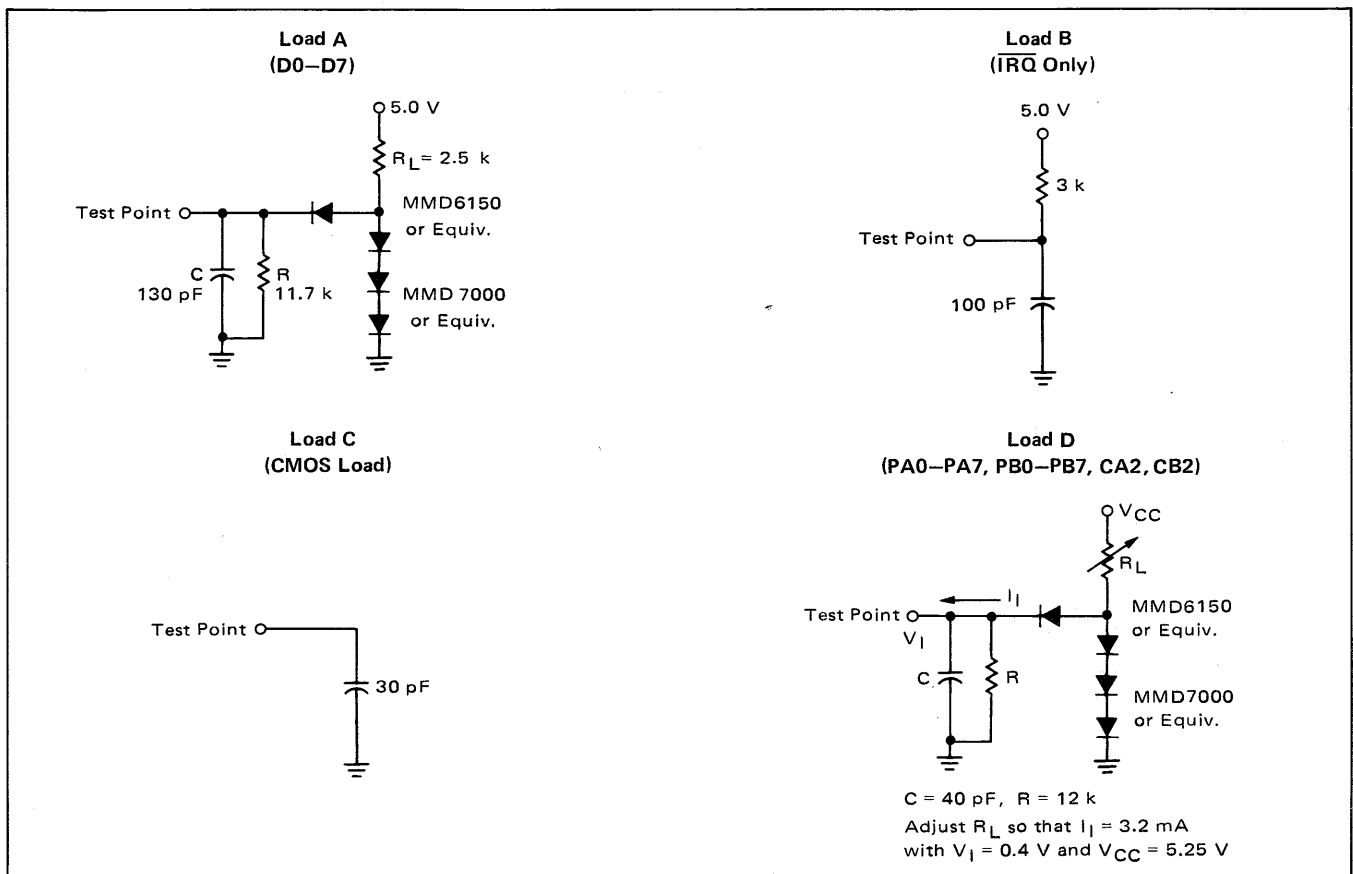

FIGURE 5 – INTERRUPT PULSE WIDTH and \overline{IRQ} RESPONSE



* Assumes Interrupt Enable Bits are set.

FIGURE 6 – BUS TIMING TEST LOADS



ASYNCHRONOUS COMMUNICATIONS INTERFACE ADAPTER (ACIA) MC68A50 • MC68B50

ELECTRICAL CHARACTERISTICS ($V_{CC} = 5.0\text{ V} \pm 5\%$, $V_{SS} = 0$, $T_A = 0$ to 70°C unless otherwise noted.)

Characteristic	Symbol	Min	Typ	Max	Unit	
Input High Voltage	V_{IH}	$V_{SS} + 2.0$	—	V_{CC}	Vdc	
Input Low Voltage	V_{IL}	$V_{SS} - 0.3$	—	$V_{SS} + 0.8$	Vdc	
Input Leakage Current ($V_{in} = 0$ to 5.25 Vdc)	R/W, CS0, CS1, $\overline{\text{CS2}}$, Enable	I_{in}	—	1.0	2.5	μAdc
Three-State (Off State) Input Current ($V_{in} = 0.4$ to 2.4 Vdc)	D0-D7	I_{TSI}	—	2.0	10	μAdc
Output High Voltage ($I_{Load} = -205\ \mu\text{Adc}$, Enable Pulse Width $< 25\ \mu\text{s}$) ($I_{Load} = -100\ \mu\text{Adc}$, Enable Pulse Width $< 25\ \mu\text{s}$)	D0-D7 Tx Data, $\overline{\text{RTS}}$	V_{OH}	$V_{SS} + 2.4$ $V_{SS} + 2.4$	— —	— —	Vdc
Output Low Voltage ($I_{Load} = 1.6\ \text{mAdc}$, Enable Pulse Width $< 25\ \mu\text{s}$)		V_{OL}	—	—	$V_{SS} + 0.4$	Vdc
Output Leakage Current (Off State) ($V_{OH} = 2.4\text{ Vdc}$)	IRQ	I_{LOH}	—	1.0	10	μAdc
Power Dissipation	P_D	—	300	525	mW	
Capacitance ($V_{in} = 0$, $T_A = 25^\circ\text{C}$, $f = 1.0\text{ MHz}$)	D0-D7 E, Tx Clk, Rx Clk, R/W, RS, Rx Data, CS0, CS1, $\overline{\text{CS2}}$, $\overline{\text{CTS}}$, $\overline{\text{DCD}}$ $\overline{\text{RTS}}$, Tx Data IRQ	C_{in}	— —	10 7.0	12.5 7.5	pF
		C_{out}	— —	— —	10 5.0	pF
Minimum Clock Pulse Width, Low	$\pm 16, \pm 64$ Modes	PW_{CL}	600	—	—	ns
Minimum Clock Pulse Width, High	$\pm 16, \pm 64$ Modes	PW_{CH}	600	—	—	ns
Clock Frequency	± 1 Mode $\pm 16, \pm 64$ Modes	f_C	— —	— —	500 800	kHz
Clock-to-Data Delay for Transmitter		t_{TDD}	—	—	1.0	μs
Receive Data Setup Time	± 1 Mode	t_{RDSU}	500	—	—	ns
Receive Data Hold Time	± 1 Mode	t_{RDH}	500	—	—	ns
Interrupt Request Release Time		t_{IR}	—	—	1.2	μs
Request-to-Send Delay Time		t_{RTS}	—	—	1.0	μs
Input Transition Times (Except Enable)		t_r, t_f	—	—	1.0*	μs

*1.0 μs or 10% of the pulse width, whichever is smaller.

BUS TIMING CHARACTERISTICS ($V_{CC} = 5.0\text{ V} \pm 5\%$, $V_{SS} = 0$, $T_A = 0$ to 70°C unless otherwise noted.)

READ

Characteristic	Symbol	MC68A50		MC68B50		Unit
		Min	Max	Min	Max	
Enable Cycle Time	t_{cycE}	0.666	—	0.50	—	μs
Enable Pulse Width, High	PW_{EH}	0.28	25	0.22	25	μs
Enable Pulse Width, Low	PW_{EL}	0.28	—	0.21	—	μs
Setup Time, Address and R/W Valid to Enable positive transition	t_{AS}	140	—	70	—	ns
Data Delay Time	t_{DDR}	—	220	—	180	ns
Data Hold Time	t_H	10	—	10	—	ns
Address Hold Time	t_{AH}	10	—	10	—	ns
Rise and Fall Time for Enable input	t_{Er}, t_{Ef}	—	25	—	25	ns

WRITE

Enable Cycle Time	t_{cycE}	0.666	—	0.50	—	μs
Enable Pulse Width, High	PW_{EH}	0.28	25	0.22	25	μs
Enable Pulse Width, Low	PW_{EL}	0.28	—	0.21	—	μs
Setup Time, Address and R/W Valid to Enable positive transition	t_{AS}	140	—	70	—	ns
Data Setup Time	t_{DSW}	80	—	60	—	ns
Data Hold Time	t_H	10	—	10	—	ns
Address Hold Time	t_{AH}	10	—	10	—	ns
Rise and Fall Time for Enable input	t_{Er}, t_{Ef}	—	25	—	25	ns



RANDOM ACCESS MEMORY (RAM)

MCM68A10 • MCM68B10

DC CHARACTERISTICS ($V_{CC} = 5.0\text{ V} \pm 5\%$, $V_{SS} = 0$, $T_A = 0$ to 70°C unless otherwise noted.)

Characteristic	Symbol	Min	Typ	Max	Unit
Input Current (A_n , R/W, \overline{CS}_n , \overline{CS}_n) ($V_{in} = 0$ to 5.25 V)	I_{in}	—	—	2.5	μA
Output High Voltage ($I_{OH} = -205\ \mu\text{A}$)	V_{OH}	2.4	—	—	Vdc
Output Low Voltage ($I_{OL} = 1.6\ \text{mA}$)	V_{OL}	—	—	0.4	Vdc
Output Leakage Current (Three-State) ($CS = 0.8\text{ V}$ or $\overline{CS} = 2.0\text{ V}$, $V_{out} = 0.4\text{ V}$ to 2.4 V)	I_{LO}	—	—	10	μA
Supply Current ($V_{CC} = 5.25\text{ V}$, all other pins grounded, $T_A = 0^\circ\text{C}$)	I_{CC}	—	—	80	mA

AC CHARACTERISTICS

READ CYCLE ($V_{CC} = 5.0\text{ V} \pm 5\%$, $V_{SS} = 0$, $T_A = 0$ to 70°C unless otherwise noted.)

Characteristic	Symbol	MCM68A10		MCM68B10		Unit
		Min	Max	Min	Max	
Read Cycle Time	$t_{cyc(R)}$	360	—	250	—	ns
Access Time	t_{acc}	—	360	—	250	ns
Address Setup Time	t_{AS}	20	—	20	—	ns
Address Hold Time	t_{AH}	0	—	0	—	ns
Data Delay Time (Read)	t_{DDR}	—	220	—	180	ns
Read to Select Delay Time	t_{RCS}	0	—	0	—	ns
Data Hold from Address	t_{DHA}	10	—	10	—	ns
Output Hold Time	t_H	10	—	10	—	ns
Data Hold from Write	t_{DHW}	10	60	10	60	ns

WRITE CYCLE ($V_{CC} = 5.0\text{ V} \pm 5\%$, $V_{SS} = 0$, $T_A = 0$ to 70°C unless otherwise noted.)

Characteristic	Symbol	MCM68A10		MCM68B10		Unit
		Min	Max	Min	Max	
Write Cycle Time	$t_{cyc(W)}$	360	—	250	—	ns
Address Setup Time	t_{AS}	20	—	20	—	ns
Address Hold Time	t_{AH}	0	—	0	—	ns
Chip Select Pulse Width	t_{CS}	250	—	210	—	ns
Write to Chip Select Delay Time	t_{WCS}	0	—	0	—	ns
Data Setup Time (Write)	t_{DSW}	80	—	60	—	ns
Input Hold Time	t_H	10	—	10	—	ns



MOTOROLA Semiconductor Products Inc.

3501 ED BLUESTEIN BLVD., AUSTIN, TEXAS 78721 • A SUBSIDIARY OF MOTOROLA INC.