

NJM2072

■ ABSOLUTE MAXIMUM RATINGS

(Ta=25°C)

PARAMETER	SYMBOL	RATINGS	UNIT
Supply Voltage	V ⁺	8	V
Power Dissipation	P _D	(DIP8) 500 (DMP8) 300	mW
Operating Temperature Range	T _{opr}	-40~+85	°C
Storage Temperature Range	T _{stg}	-40~+125	°C
Maximum Input Voltage	V _{imax}	V ⁺ -1	V

■ ELECTRICAL CHARACTERISTICS

(Ta=25°C, V⁺=3V)

PARAMETER	SYMBOL	TEST CONDITION	MIN.	TYP.	MAX.	UNIT
Operating Voltage	V ⁺		0.9	-	7	V
Operating Current	I _{CC}	V _{in} =0mVrms, R _L =∞	0.2	0.55	1.5	mA
Input Sensitivity	V _{ins}	f=1kHz	-39	-36	-33	dBV
Attack Time (note1)	T _{atc}	f=1kHz, C _R =10μF	-	1	25	mSec
Recovery Time (note2)	T _{rec}	f=1kHz, C _R =10μF	-	2	-	Sec
Output Current at ON (OUT1)	I _{O1 on}	V _{in} =30mVrms, V _O =0.3V	1	3	-	mA
Output Current at ON (OUT2)	I _{O2 on}	V _{in} =0mVrms, V _O =0.3V	1	3	-	mA
Output Current at OFF (OUT1)	I _{O1 off}	V _{in} =0mVrms, V _O =8V	-	-	1	μA
Output Current at OFF (OUT2)	I _{O2 off}	V _{in} =30mVrms, V _O =8V	-	-	1	μA
Input Resistance	R _{in}		16	20	24	kΩ
Charge Current	I _{chg}		1.0	2.0	3.0	μA

(note1) Attack Time: Period from putting input signal of more than minimum input sensitive signal to output level change.

(note2) Recovery Time: Period from input signal becoming lower than minimum input sensitive signal to output level change.

■ TYPICAL CHARACTERISTICS

**Operating Current
vs. Operating Voltage**

(Ta=25°C)

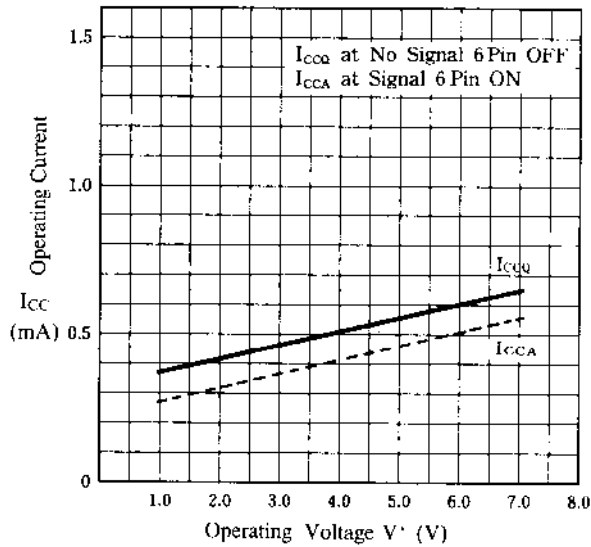

**Input Sensitivity
vs. Operating Voltage**

(Ta=25°C, f=1kHz)

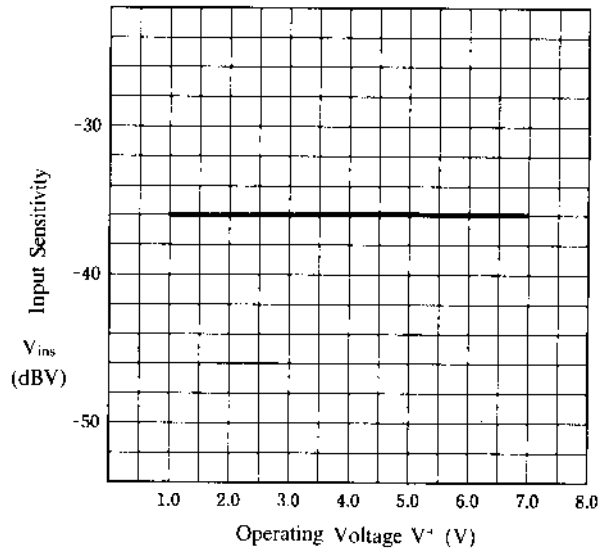

**Output Voltage
vs. Input Voltage**

(V+=3V, f=1kHz, 6 Pin, Ta=25°C)

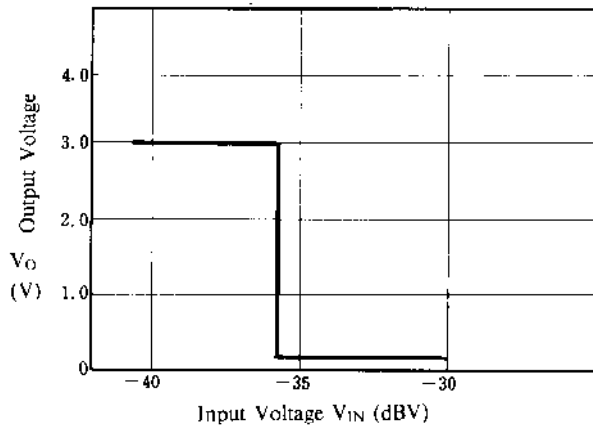

**Output Current at ON
vs. Output Voltage**

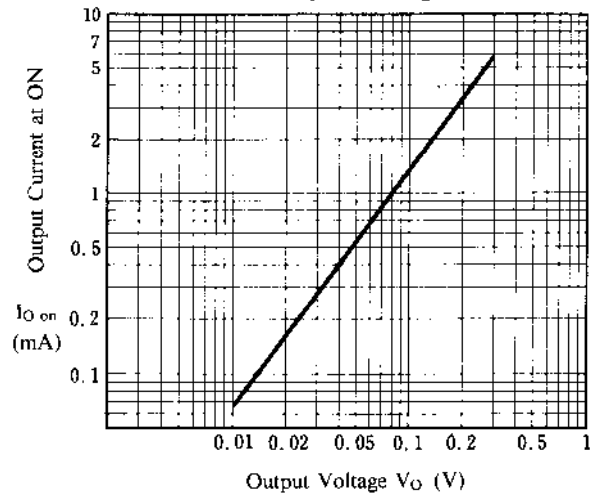

**Input Sensitivity
vs. Frequency**

(V+=3V)

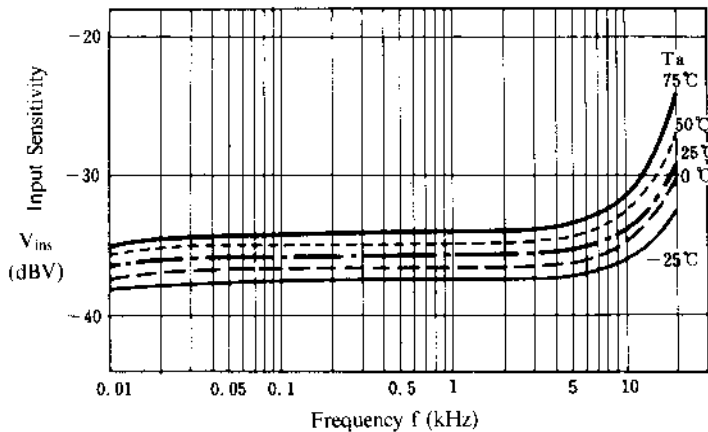

**Input Sensitivity
vs. Ambient Temperature**

(V+=3V, f=1kHz)

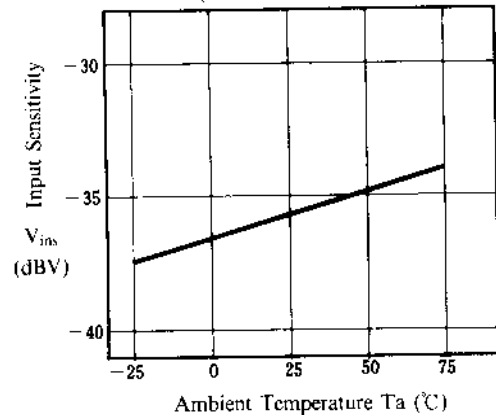

■ TYPICAL CHARACTERISTICS

Recovery Time vs. Operating Voltage
($T_a = 25^\circ\text{C}$, $C_R = 10\mu\text{F}$)

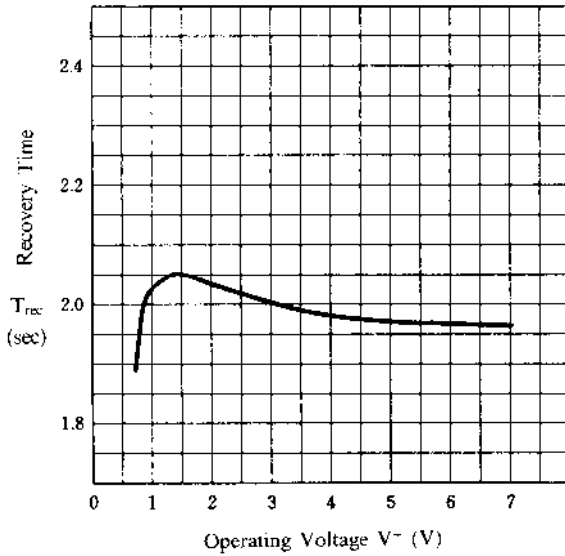

Input Sensitivity Recovery Time vs. Ambient Temperature
($V^+ = 3\text{V}$, $C_R = 10\mu\text{F}$)

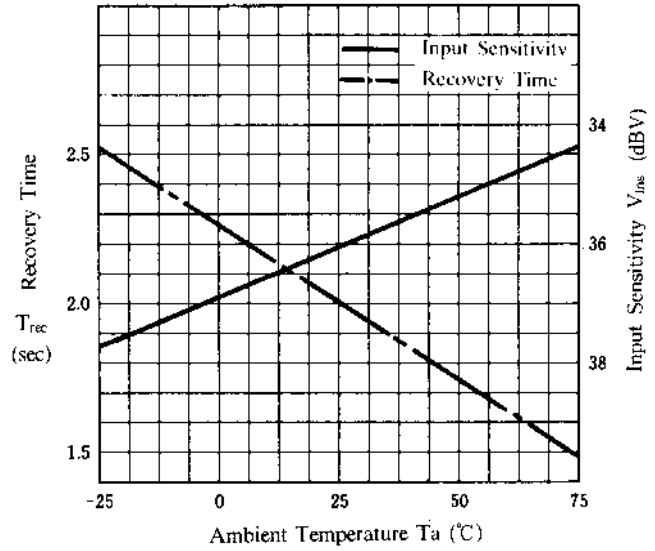

Recovery Time Characteristics
($f = 1\text{kHz}$)

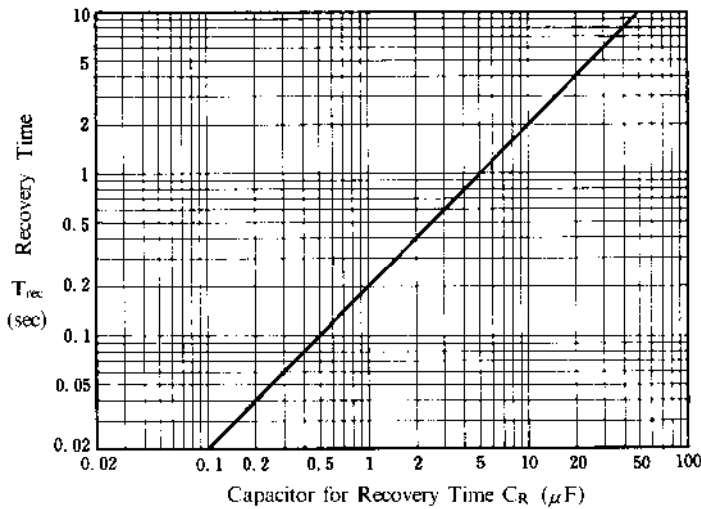

Input Sensitivity vs. Operating Voltage
($f = 1\text{kHz}$)

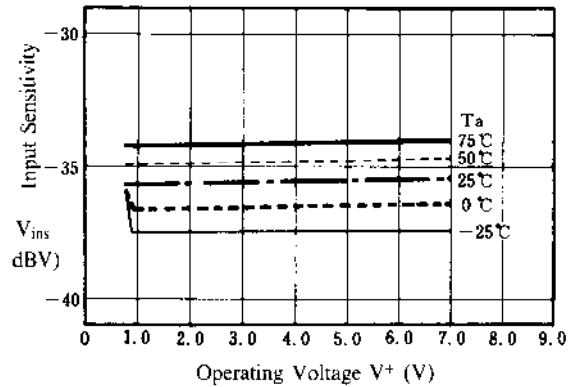

■ TYPICAL APPLICATIONS

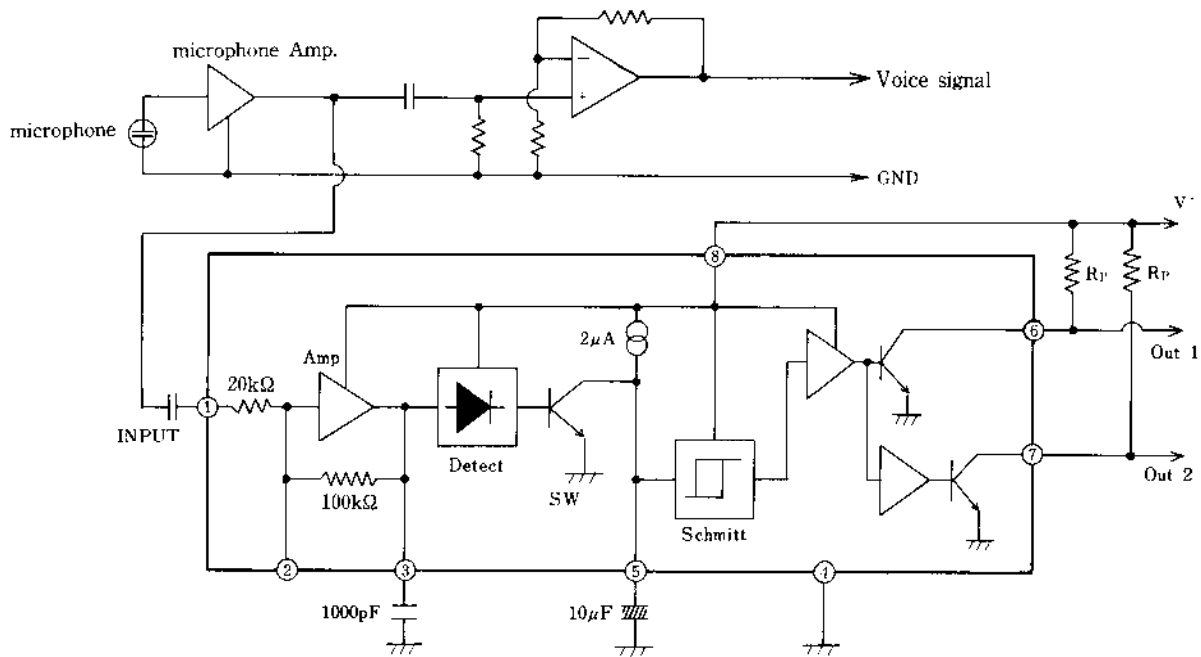

Pins 6 and 7 show an open collector. Mount resistor R_P shown by the following equation.

$$R_P = (V_{MIN}^+ - 0.2) / 0.3 \text{ (k}\Omega\text{)}$$

Resistor R_P to pin 7 is omissible, if pin 6 only is used. But resistor R_P to pin 6 should be put when Out2 only is used.

V_{MIN}^+ is minimum supply voltage.

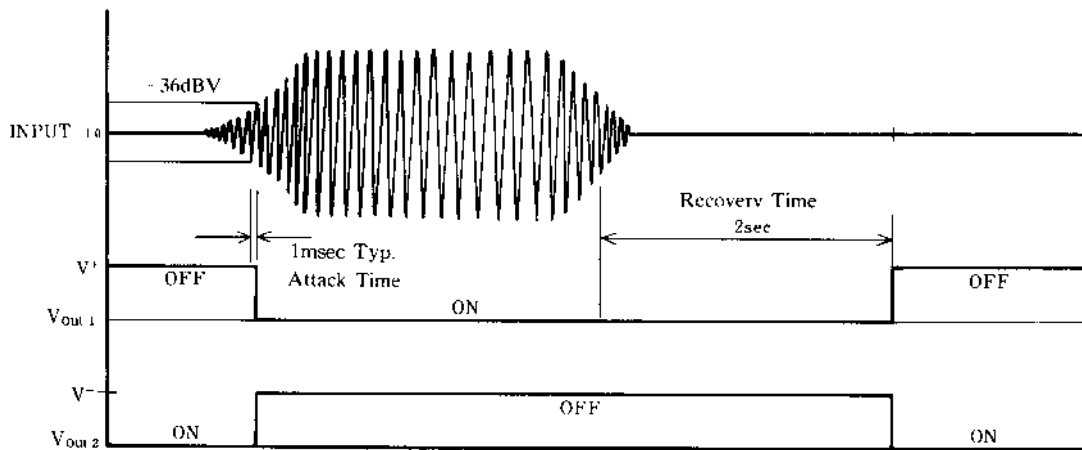

[CAUTION]
The specifications on this databook are only given for information, without any guarantee as regards either mistakes or omissions. The application circuits in this databook are described only to show representative usages of the product and not intended for the guarantee or permission of any right including the industrial rights.