

TOSHIBA FIELD EFFECT TRANSISTOR SILICON N CHANNEL MOS TYPE

2SK241

FM TUNER, VHF AND RF AMPLIFIER APPLICATIONS.

Unit in mm

- Low Reverse Transfer Capacitance : $C_{rss} = 0.035\text{pF}$ (Typ.)
- Low Noise Figure : $NF = 1.7\text{dB}$ (Typ.)
- High Power Gain : $G_{ps} = 28\text{dB}$ (Typ.)
- Recommend Operation Voltage : $5\sim 15\text{V}$

MAXIMUM RATINGS ($T_a = 25^\circ\text{C}$)

CHARACTERISTIC	SYMBOL	RATING	UNIT
Drain-Source Voltage	V_{DS}	20	V
Gate-Source Voltage	V_{GS}	± 5	V
Drain Current	I_D	30	mA
Drain Power Dissipation	P_D	200	mW
Chanel Temperature	T_{ch}	125	$^\circ\text{C}$
Storage Temperature Range	T_{stg}	$-55\sim 125$	$^\circ\text{C}$

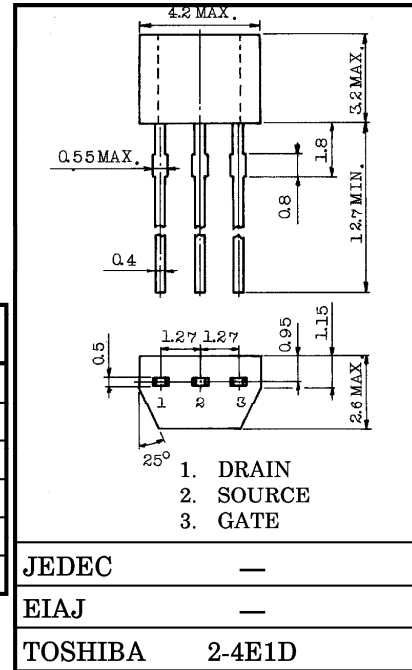

ELECTRICAL CHARACTERISTICS ($T_a = 25^\circ\text{C}$)

Weight : 0.13g

CHARACTERISTIC	SYMBOL	TEST CONDITION	MIN.	TYP.	MAX.	UNIT
Gate Leakage Current	I_{GSS}	$V_{DS} = 0, V_{GS} = \pm 5\text{V}$	—	—	± 50	nA
Drain-Source Voltage	V_{DSX}	$V_{GS} = -4\text{V}, I_D = 100\mu\text{A}$	20	—	—	V
Drain Current	I_{DSS}	$V_{DS} = 10\text{V}, V_{GS} = 0$ (Note)	1.5	—	14	mA
Gate-Source Cut-off Voltage	$V_{GS(OFF)}$	$V_{DS} = 10\text{V}, I_D = 100\mu\text{A}$	—	—	-2.5	V
Forward Transfer Admittance	$ y_{fs} $	$V_{DS} = 10\text{V}, V_{GS} = 0, f = 1\text{kHz}$	—	10	—	mS
Input Capacitance	C_{iss}	$V_{DS} = 10\text{V}, V_{GS} = 0, f = 1\text{MHz}$	—	3.0	—	pF
Reverse Transfer Capacitance	C_{rss}		—	0.035	0.050	pF
Power Gain	G_{ps}	$V_{DS} = 10\text{V}, V_{GS} = 0, f = 100\text{MHz}$ (Fig.1)	—	28	—	dB
Noise Figure	NF		—	1.7	3.0	dB

Note : I_{DSS} Classification O : 1.5~3.5, Y : 3.0~7.0, GR : 6.0~14.0

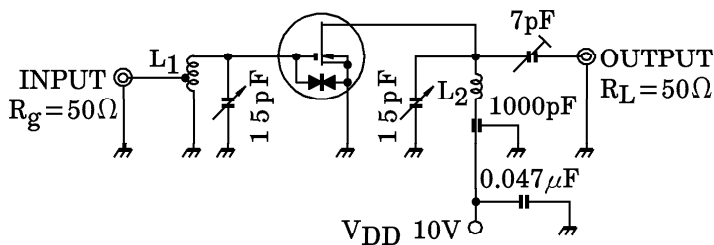

- L_1 : 1.0mm ϕ SILVER PLATED COPPER WIRE 4.0T, 8mm ϕ ID TAPAT 1.0T FROM COLD END
- L_2 : 1.0mm ϕ SILVER PLATED COPPER WIRE 3.0T, 8mm ϕ ID, 10mm LENGTH

Fig.1 G_{ps} , NF TEST CIRCUIT

961001EAA2

● TOSHIBA is continually working to improve the quality and the reliability of its products. Nevertheless, semiconductor devices in general can malfunction or fail due to their inherent electrical sensitivity and vulnerability to physical stress. It is the responsibility of the buyer, when utilizing TOSHIBA products, to observe standards of safety, and to avoid situations in which a malfunction or failure of a TOSHIBA product could cause loss of human life, bodily injury or damage to property. In developing your designs, please ensure that TOSHIBA products are used within specified operating ranges as set forth in the most recent products specifications. Also, please keep in mind the precautions and conditions set forth in the TOSHIBA Semiconductor Reliability Handbook.

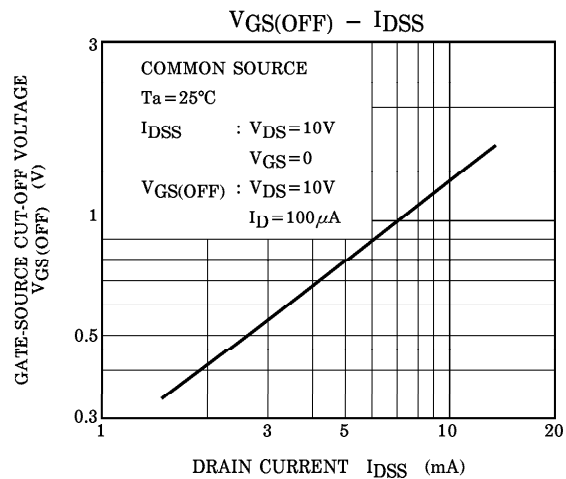
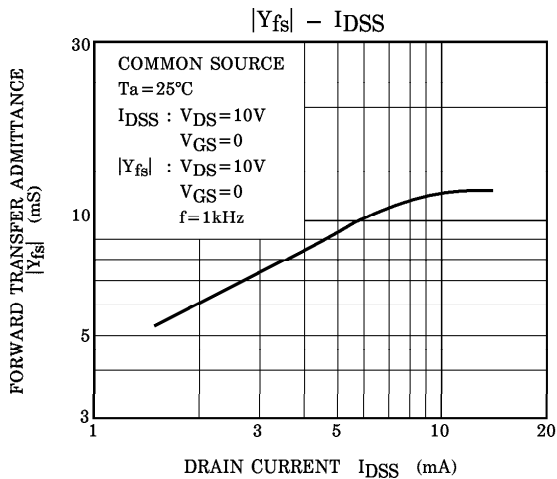
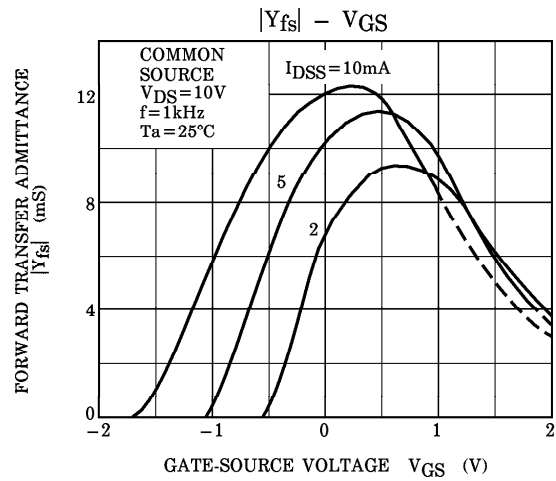
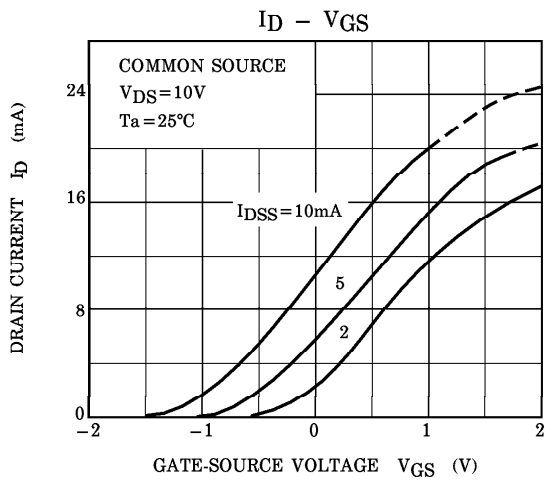
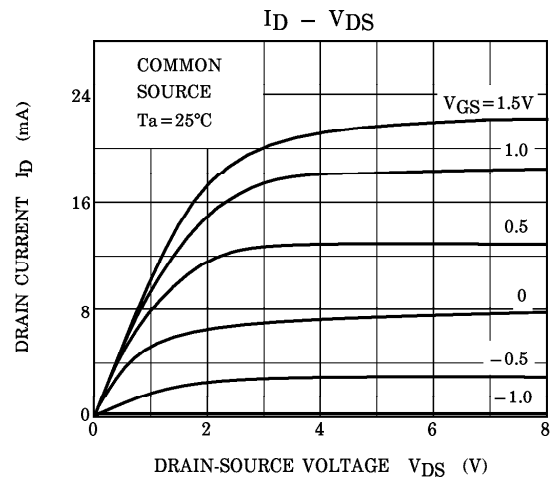
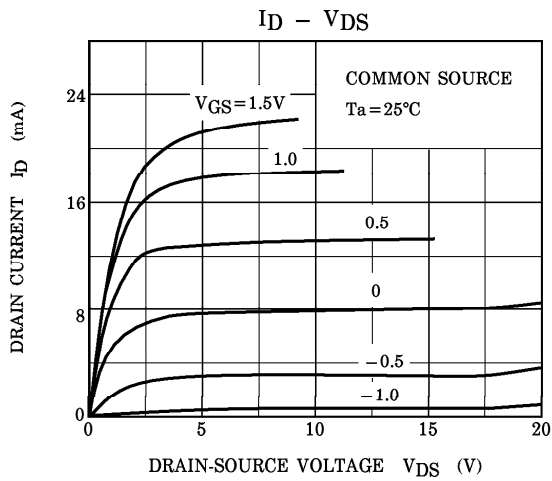

961001EAA2'

● The information contained herein is presented only as a guide for the applications of our products. No responsibility is assumed by TOSHIBA CORPORATION for any infringements of intellectual property or other rights of the third parties which may result from its use. No license is granted by implication or otherwise under any intellectual property or other rights of TOSHIBA CORPORATION or others.
 ● The information contained herein is subject to change without notice.

