

TOSHIBA INFRARED LED GaAs INFRARED EMITTER

# TLN101A

INFRARED LED FOR PHOTO SENSOR

Unit in mm

OPTO-ELECTRONIC SWITCH

SMOKE SENSOR

INFRARED RAYS APPLIED EQUIPMENT

ROTARY ENCODER

LINEAR SCALE

- Excellent linearity of radiant power and modulation by pulse operation and high frequency is possible.
- Highly reliable because of hermetic seal.
- The same external shape as Photo Transistors TPS601A and TPS604.

MAXIMUM RATINGS (Ta = 25°C)

CHARACTERISTIC	SYMBOL	RATING	UNIT
Forward Current	$I_F$	100	mA
Forward Current Derating (Ta > 25°C)	$\Delta I_F / ^\circ C$	-1	mA / °C
Pulse Forward Current (Note)	$I_{FP}$	1	A
Reverse Voltage	$V_R$	5	V
Operating Temperature Range	$T_{opr}$	-40~125	°C
Storage Temperature Range	$T_{stg}$	-55~150	°C

(Note) Pulse Width  $\leq 100\mu s$ , Repetitive Frequency = 100Hz

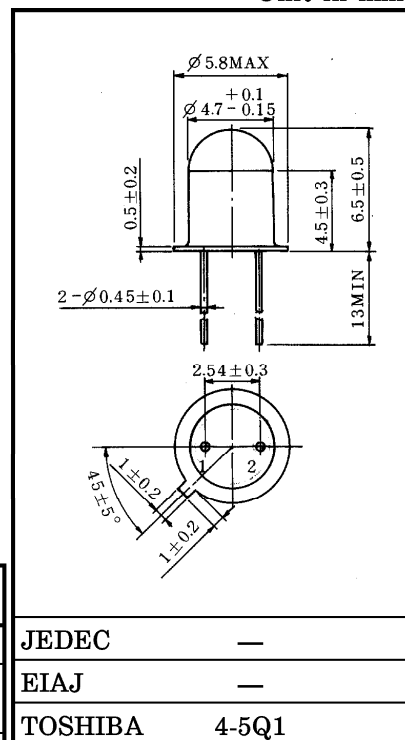

JEDEC	—
EIAJ	—
TOSHIBA	4-5Q1

Weight : 0.39g (TYP.)

PIN CONNECTION



1. ANODE
2. CATHODE (CASE)

OPTO-ELECTRICAL CHARACTERISTICS (Ta = 25°C)

CHARACTERISTIC	SYMBOL	TEST CONDITION	MIN.	TYP.	MAX.	UNIT	
Forward Voltage	$V_F$	$I_F = 50mA$	—	1.3	1.4	V	
Pulse Forward Voltage	$V_{FP}$	$I_{FP} = 1A$	—	2.4	—	V	
Reverse Current	$I_R$	$V_R = 5V$	—	—	10	$\mu A$	
Radiant Intensity	$I_E$	$I_F = 50mA$	—	15	—	mW / sr	
Radiant Power	$P_o$	$I_F = 50mA$	TLN101A	1.5	—	—	mW
			TLN101A-C	1.5	—	4.5	
Capacitance	$C_T$	$V_R = 0, f = 1MHz$	—	30	—	pF	
Peak Emission Wavelength	$\lambda_p$	$I_F = 50mA$	—	940	—	nm	
Spectral Line Half Width	$\Delta\lambda$	$I_F = 50mA$	—	50	—	nm	
Half Value Angle	$\theta_{\frac{1}{2}}$	$I_F = 50mA$	—	$\pm 4$	—	°	

961001EAC2

● TOSHIBA is continually working to improve the quality and the reliability of its products. Nevertheless, semiconductor devices in general can malfunction or fail due to their inherent electrical sensitivity and vulnerability to physical stress. It is the responsibility of the buyer, when utilizing TOSHIBA products, to observe standards of safety, and to avoid situations in which a malfunction or failure of a TOSHIBA product could cause loss of human life, bodily injury or damage to property. In developing your designs, please ensure that TOSHIBA products are used within specified operating ranges as set forth in the most recent products specifications. Also, please keep in mind the precautions and conditions set forth in the TOSHIBA Semiconductor Reliability Handbook.

## PRODUCT INDICATION

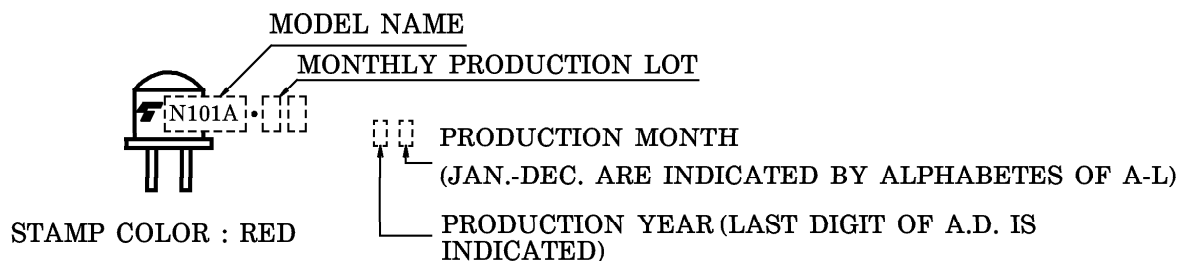

## PRECAUTION

Please be careful of the followings.

1. Soldering temperature : 260°C MAX.  
Soldering time : 5s MAX.  
(Soldering portion of lead : above 1.5mm from the body of the device)
2. If the lead is formed, the lead should be formed at a distance of 2mm from the body of the device.  
Soldering shall be performed after lead forming.

961001EAC2'

- Gallium arsenide (GaAs) is a substance used in the products described in this document. GaAs dust and fumes are toxic. Do not break, cut or pulverize the product, or use chemicals to dissolve them. When disposing of the products, follow the appropriate regulations. Do not dispose of the products with other industrial waste or with domestic garbage.
- The information contained herein is presented only as a guide for the applications of our products. No responsibility is assumed by TOSHIBA CORPORATION for any infringements of intellectual property or other rights of the third parties which may result from its use. No license is granted by implication or otherwise under any intellectual property or other rights of TOSHIBA CORPORATION or others.
- The information contained herein is subject to change without notice.

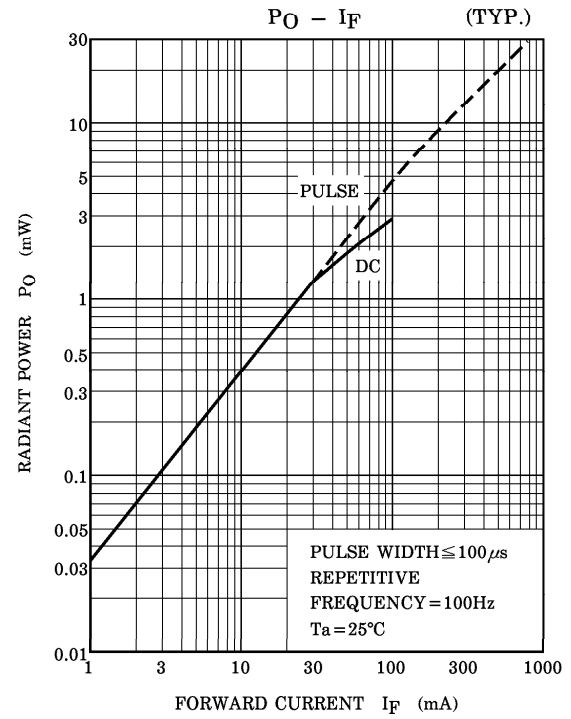
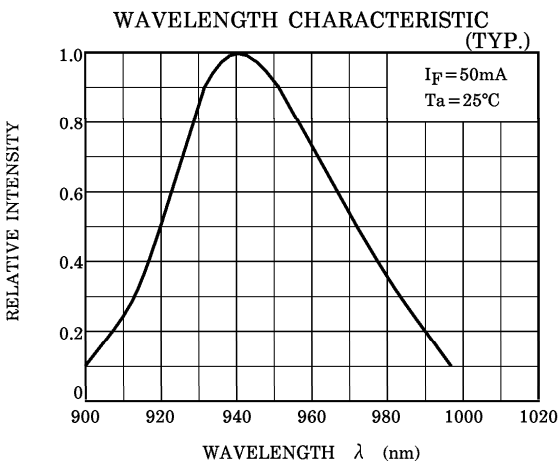
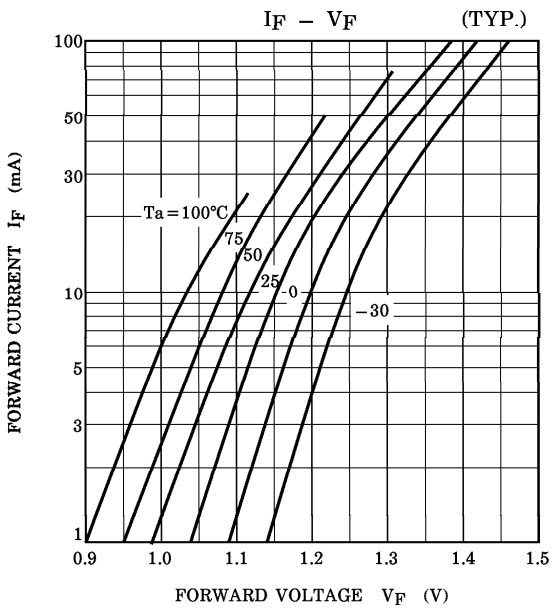
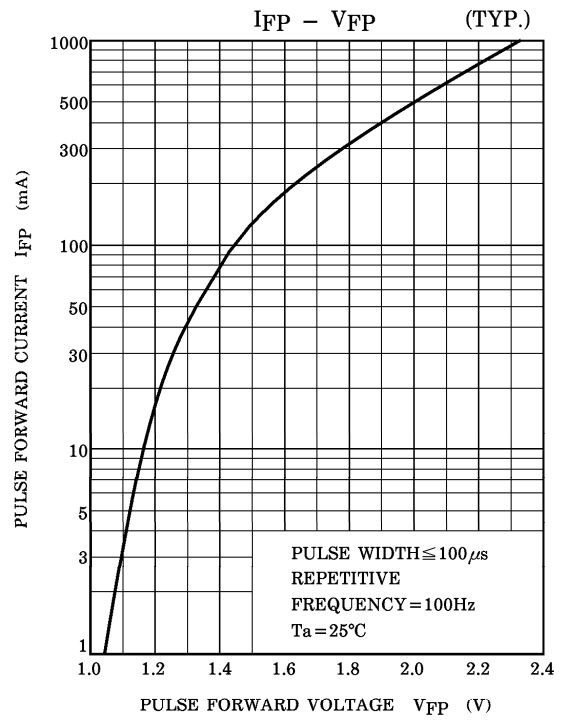
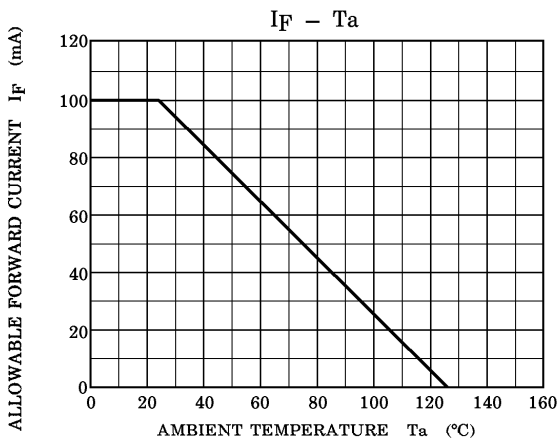

**RADIATION PATTERN (TYP.)**  
( $T_a = 25^\circ\text{C}$ )

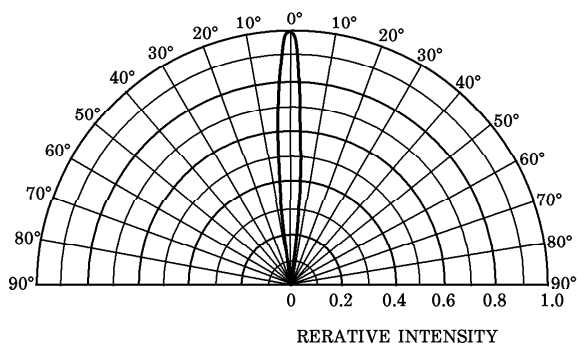

**RELATIVE  $P_O - T_a$  (TYP.)**

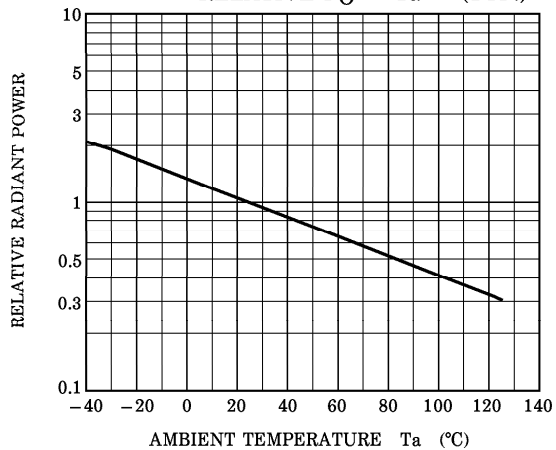

**$I_{FP} - P_W$**

