

Features

- Diffused Junction
- Low Forward Voltage Drop
- High Current Capability
- High Reliability
- High Surge Current Capability

Mechanical Data

- Case: Molded Plastic
- Terminals: Plated Leads Solderable per MIL-STD-202, Method 208
- Polarity: Cathode Band
- Weight: 2.1 grams (approx.)
- Mounting Position: Any
- Marking: Type Number
- Epoxy: UL 94V-O rate flame retardant

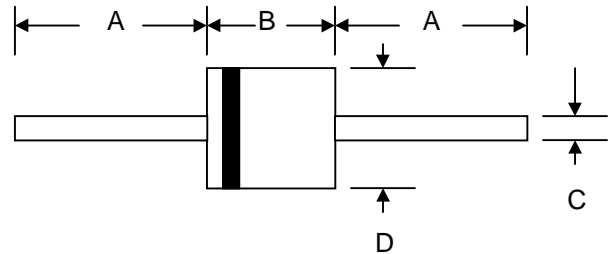

R-6		
Dim	Min	Max
A	25.4	—
B	8.60	9.10
C	1.20	1.30
D	8.60	9.10
All Dimensions in mm		

Maximum Ratings and Electrical Characteristics @ $T_A=25^\circ\text{C}$ unless otherwise specified

Single Phase, half wave, 60Hz, resistive or inductive load.
 For capacitive load, derate current by 20%.

Characteristic	Symbol	HER 601	HER 602	HER 603	HER 604	HER 605	HER 606	HER 607	HER 608	Unit
Peak Repetitive Reverse Voltage	V_{RRM}	50	100	200	300	400	600	800	1000	V
Working Peak Reverse Voltage	V_{RWM}									
DC Blocking Voltage	V_R									
RMS Reverse Voltage	$V_{R(RMS)}$	35	70	140	210	280	420	560	700	V
Average Rectified Output Current (Note 1)	I_o	6.0								A
		@ $T_A = 55^\circ\text{C}$								
Non-Repetitive Peak Forward Surge Current	I_{FSM}	200								A
		8.3ms Single half sine-wave superimposed on rated load (JEDEC Method)								
Forward Voltage	V_{FM}	1.0				1.3	1.7			V
		@ $I_F = 6.0\text{A}$								
Peak Reverse Current	I_{RM}	10.0								μA
		@ $T_A = 25^\circ\text{C}$								
		@ $T_A = 100^\circ\text{C}$								
Reverse Recovery Time (Note 2)	t_{rr}	50				75			nS	
Typical Junction Capacitance (Note 3)	C_j	100				65			pF	
Operating Temperature Range	T_j	-65 to +125								$^\circ\text{C}$
Storage Temperature Range	T_{STG}	-65 to +150								$^\circ\text{C}$

*Glass passivated forms are available upon request

Note: 1. Leads maintained at ambient temperature at a distance of 9.5mm from the case

2. Measured with $I_F = 0.5\text{A}$, $I_R = 1.0\text{A}$, $I_{RR} = 0.25\text{A}$. See figure 5.

3. Measured at 1.0 MHz and applied reverse voltage of 4.0V D.C.

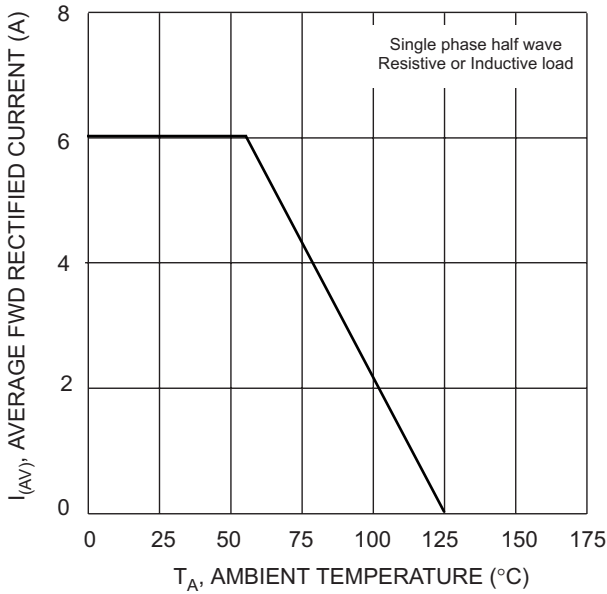

Fig. 1 Forward Current Derating Curve

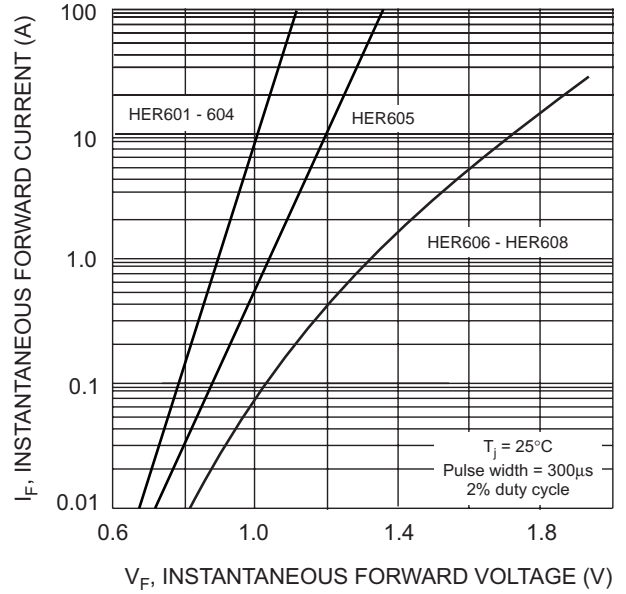

Fig. 2 Typical Forward Characteristics

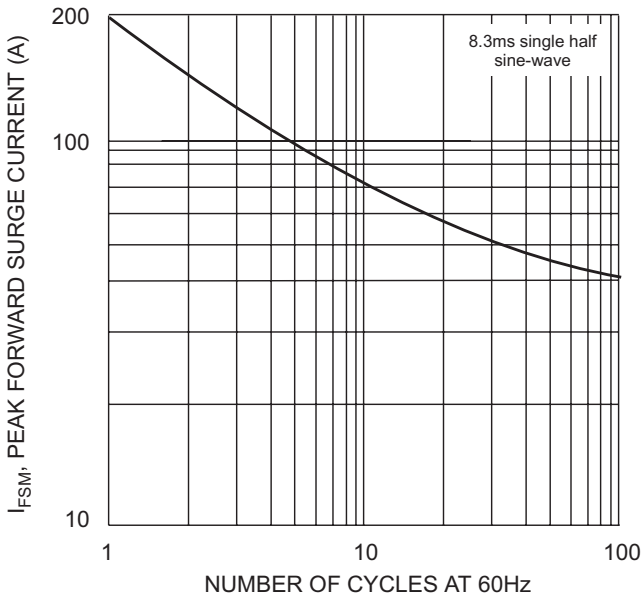

Fig. 3 Peak Forward Surge Current

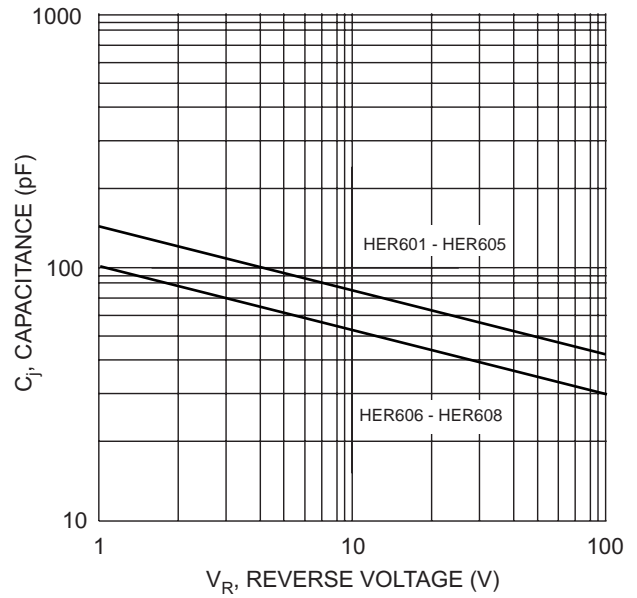
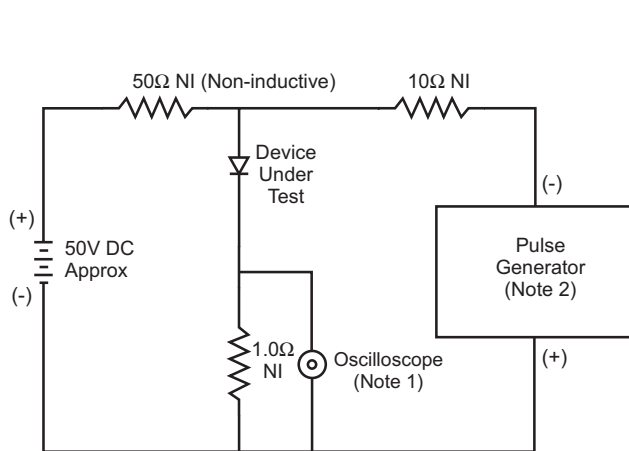
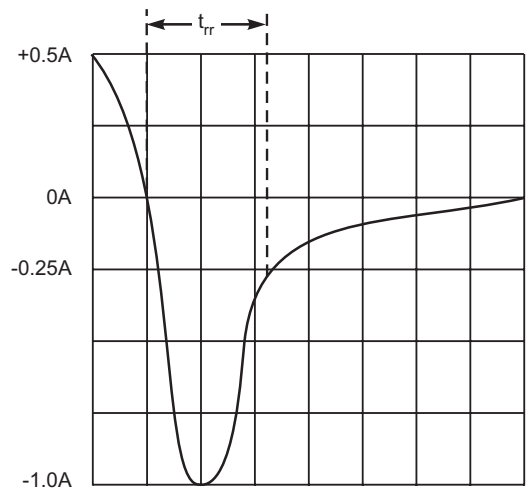

Fig. 4 Typical Junction Capacitance



- Notes:
1. Rise Time = 7.0ns max. Input Impedance = 1.0MΩ, 22pF.
 2. Rise Time = 10ns max. Input Impedance = 50Ω.



Set time base for 5/10ns/cm

Fig. 5 Reverse Recovery Time Characteristic and Test Circuit

ORDERING INFORMATION

Product No.♦	Package Type	Shipping Quantity
HER601-T3	R-6	800/Tape & Reel
HER601	R-6	250 Units/Box
HER602-T3	R-6	800/Tape & Reel
HER602	R-6	250 Units/Box
HER603-T3	R-6	800/Tape & Reel
HER603	R-6	250 Units/Box
HER604-T3	R-6	800/Tape & Reel
HER604	R-6	250 Units/Box
HER605-T3	R-6	800/Tape & Reel
HER605	R-6	250 Units/Box
HER606-T3	R-6	800/Tape & Reel
HER606	R-6	250 Units/Box
HER607-T3	R-6	800/Tape & Reel
HER607	R-6	250 Units/Box
HER608-T3	R-6	800/Tape & Reel
HER608	R-6	250 Units/Box

Products listed in **bold** are WTE **Preferred** devices.

♦T3 suffix refers to a 13" reel.

Shipping quantity given is for minimum packing quantity only. For minimum order quantity, please consult the Sales Department.

Won-Top Electronics Co., Ltd (WTE) has checked all information carefully and believes it to be correct and accurate. However, WTE cannot assume any responsibility for inaccuracies. Furthermore, this information does not give the purchaser of semiconductor devices any license under patent rights to manufacturer. WTE reserves the right to change any or all information herein without further notice.

WARNING: DO NOT USE IN LIFE SUPPORT EQUIPMENT. WTE power semiconductor products are not authorized for use as critical components in life support devices or systems without the express written approval.

Won-Top Electronics Co., Ltd.

No. 44 Yu Kang North 3rd Road, Chine Chen Dist., Kaohsiung, Taiwan

Phone: 886-7-822-5408 or 886-7-822-5410

Fax: 886-7-822-5417

Email: sales@wontop.com

Internet: http://www.wontop.com

We power your everyday.